

I. Introduction

A. Historical Experience

Based on over thirty years experience in the butterfly industry, Bray can state without question the majority of all field problems for butterfly valves are directly related to poor installation procedures. For this reason, it is very important all distributor salespeople educate their customers regarding proper installation of butterfly valves. In this case, a small amount of education in the beginning can make most butterfly valve installation trouble-free and an easy and enjoyable experience for the piping personnel.

B. Butterfly Valve Seat / Disc Function

Before reviewing the proper installation, maintenance, and repair procedures for butterfly valves, let's discuss the seat-disc function of a butterfly valve. The seat in a resilient-seated butterfly valve, whether like Bray's or hardback in design, generally has molded o-rings on the flange face of the seat. **As a result, no gaskets are required as these o-rings serve the function of a gasket.** Before installation, the flange face and molded o-rings of the seat extend beyond the body face-to-face to ensure sealing at the flange faces. The seat material which extends past the face is compressed in installation and flows toward the center of the valve seat I.D. In essence, the elastomer seat acts as a liquid, and the displaced elastomer moves toward the point of least resistance. As one may recall, the seat I.D. of all resilient-seated butterfly valves is smaller than the disc O.D. This difference, the disc-seat interference, plus the increased interference due to the elastomer movement toward the seat center after installation, has been engineered by all reputable manufacturers so as to be the basis for pressure rating capability and the related seating/unseating torques. **Any change in this interference due to improper installation directly affects the pressure rating and seating/unseating torques.**

Finally, unlike many valve types, the butterfly valve's disc actually extends beyond the face of the valve body at given angles of opening (say, 30° or more) when installed between flanges. **Therefore, it is very important before installation to ensure the critical chord dimension of the disc at the full open position is less than the adjacent pipe flange I.D.**

Given this brief discussion on the butterfly valve seat and disc, the following is a discussion of recommended procedures to ensure proper installation and maintenance of Bray butterfly valves.

II. Shipment & Storage

- A. The seat, disc, stem, and bushing of the butterfly valve should be coated with silicone lubricant as recommended by Bray Technical Bulletin 1028.
- B. The disc should be positioned at 10° open.
- C. The faces of each valve should be covered with cardboard, plywood, plastic plates, etc. to prevent damage to the seat face, disc edge, or butterfly valve interior.
- D. Valves should be stored indoors with face protectors intact. Temperature should preferably be 40°F to 85°F.
- E. When valves are stored for a long time, open and close the valves once every 3 months.
- F. Ship and store valves so that no heavy loads are applied to the bodies.

III. Installation Considerations - Piping and Valve Orientation and Placement

A. Piping and Flange Compatibilities

The Series 20, 21, 30, 31, and 34 butterfly valves have been designed to be suitable for all types of ANSI 125/150 flanges, whether flat-faced, raised face, slip-on, weld-neck, etc. (Type C stub-end flanges conform to no standard for the flange face and are not recommended for use with resilient-seated butterfly valves.) These valves have been engineered so that the critical disc chord dimension at the full open position will clear the adjacent inside diameter of most types of piping, including Schedule 40, lined pipe, heavy wall, etc. If in question, one should compare the minimum pipe I.D. with the published disc chord dimension at full open.

B. Valve Location and Orientation in Piping

1. Valve Location

- a. Butterfly valves should be installed if possible a minimum of 6 pipe diameters from other line elements, i.e., elbows, pumps, valves, etc. Of course, 6 pipe diameters are not always practical, but it is important to achieve as much distance as possible.
- b. Where the butterfly valve is connected to a check valve or pump, use an expansion joint between them to ensure the disc does not interfere with the adjacent equipment.

2. Valve Orientation

- a. In general, Bray recommends the valve be installed with the stem in the vertical position and the actuator mounted vertically directly above the valve; however, there are those applications as discussed below where the stem should be horizontal. Valves should not be installed upside down.
- b. **For slurries, sludge, mine tailing, pulp stock, dry cement, and any media with sediment or particles, Bray recommends the valve be installed with the stem in the horizontal position with the lower disc edge opening in the downstream direction.**

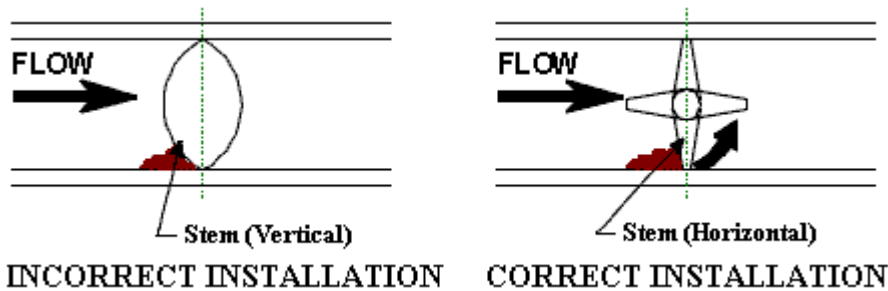

c. Butterfly valve located at the discharge of a pump should be oriented as follows:

- i.) For Centrifugal Pump - Pump shaft horizontal and stem vertical

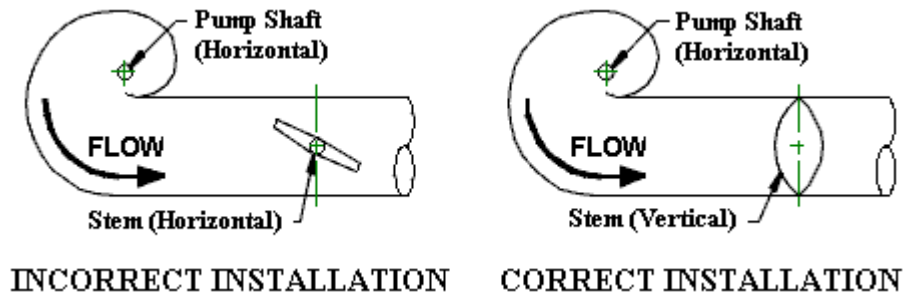

ii.) Centrifugal Pump - Pump shaft vertical & stem horizontal

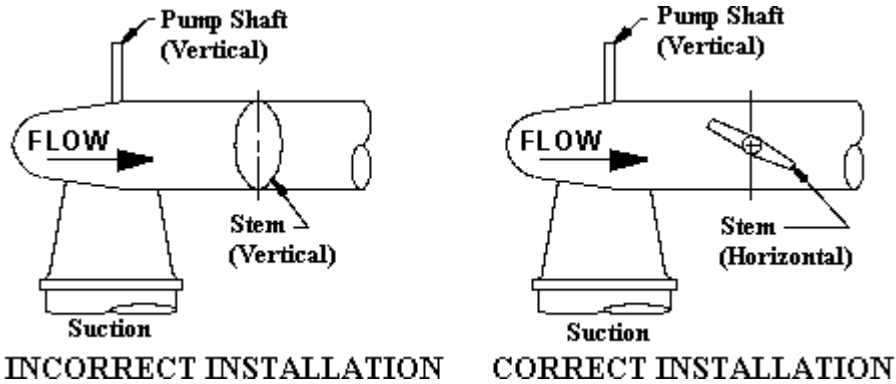

iii.) Axial Pump - Pump shaft vertical & stem vertical

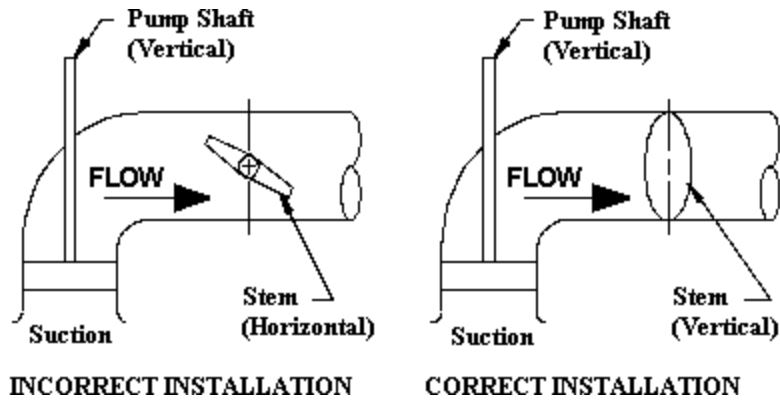

d. Butterfly valves located downstream of a bend or pipe reducer should be oriented as follows:

i.) Bend

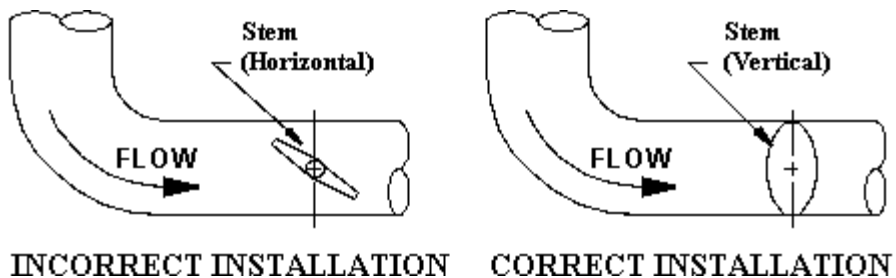

ii.) Tee

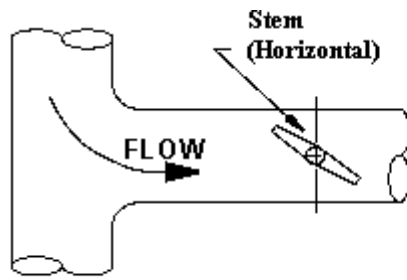

INCORRECT INSTALLATION

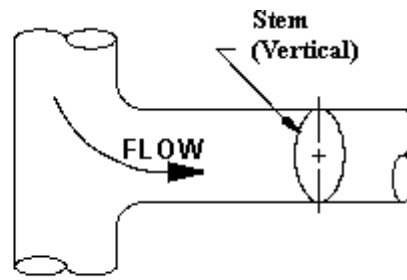

CORRECT INSTALLATION

iii.) Pipe Reducer

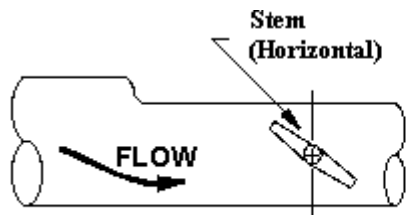

INCORRECT INSTALLATION

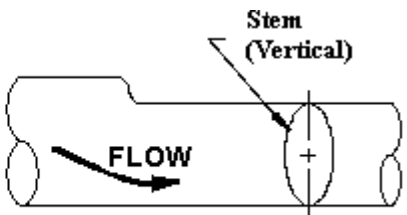

CORRECT INSTALLATION

e. Butterfly valves in combination for control/isolation applications should be installed as follows:

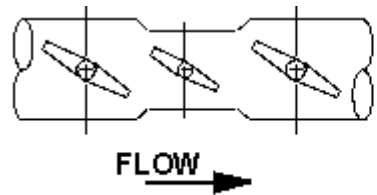

INCORRECT INSTALLATION

Combination with all valve stems in the same direction accelerates possible noise, vibration, & erosion problems.

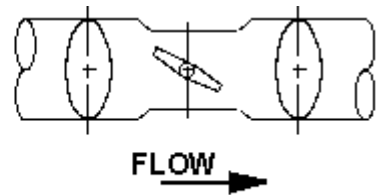

CORRECT INSTALLATION

Combination with the stem of the control valve at right angle to those of other valves tends to cancel the drift of the fluid, and reduces noises, vibration, and erosion

IV. Installation Procedure

A. General Installation

1. Make sure the pipeline and pipe flange faces are clean. Any foreign material such as pipe scale, metal chips, welding slag, welding rods, etc., can obstruct disc movement or damage the disc or seat.
2. The Bray elastomer seat has molded o-rings on the face of the seat. **As a result, no gaskets are required as these o-rings serve the function of a gasket.**

3. Align the piping and then spread the pipe flanges a distance apart so as to permit the valve body to be easily dropped between the flanges without contacting the pipe flanges (*see figure 1 below*)
4. Check to see that the valve disc has been positioned to a partially open position, with the disc edge about 1/4" to 3/8" from the face of the seat, approximately 10° open (*see figure 1 below*)
5. Insert the valve between the flanges as shown below, taking care not to damage the seat faces. Always pick the valve up by the locating holes or by using a nylon sling on the neck of the body. Never pick up the valve by the actuator or operator mounted on top of the valve.

Figure 1 - Insert Butterfly Valve Between Flanges

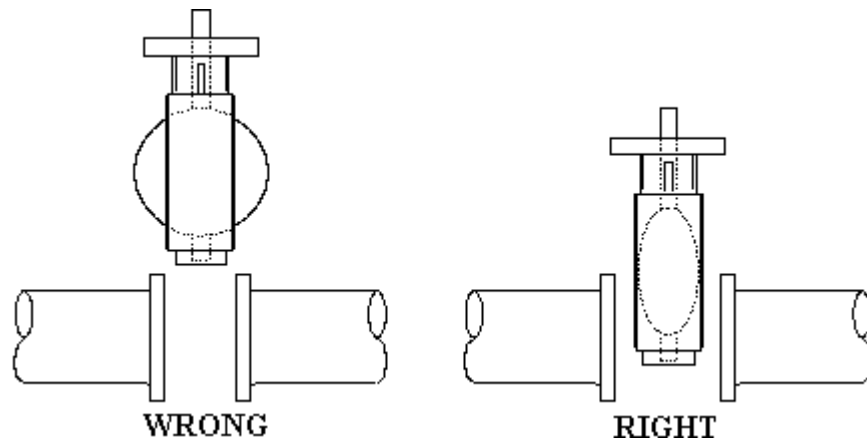

Pipe not spread, disc opened beyond valve body face; Results; Disc edge damaged when it hits pipe flange.

Pipe spread and aligned, disc rotated; Results; no undesirable beginning seating/unseating torque, disc edge protected.

6. Place the valve between the flanges, center it, and then span the valve body with all flange bolts, but do not tighten the bolts. Carefully open the disc to the full open position, making sure the disc does not hit the adjacent pipe I.D. Now systematically remove jack bolts or other flange spreaders, and hand-tighten the flange bolts as shown in Figure 2. Very slowly close the valve disc to ensure disc edge clearance from the adjacent pipe flange I.D. Now open the disc to full open and tighten all flange bolts per specification as shown in Figure 2. Finally, repeat a full close to full open rotation of the disc to ensure proper clearances (*See figures 3 & 4 below*).

Figure 2 - Recommended Bolt Tightening Sequence

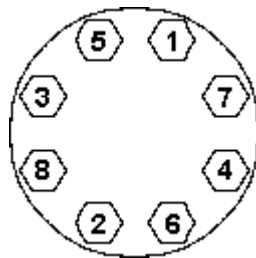
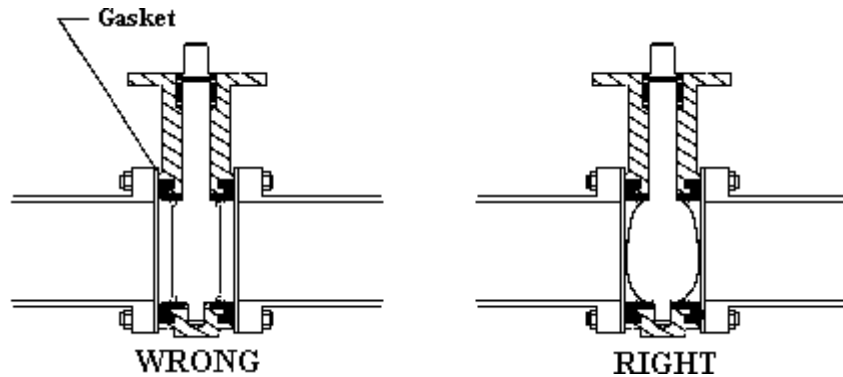

Figure 3 - Initial Centering & Flanging of Valve



Disc in closed position; gaskets used; Results - Seat distorted and over-compressed causing high initial unseating torque problems.

Bolts spanned, disc edge within body face-to-face, no flange gaskets; Results - No disc edge damage, proper sealing allowed.

Figure 4 - Final Aligning & Tightening of Flange Bolts

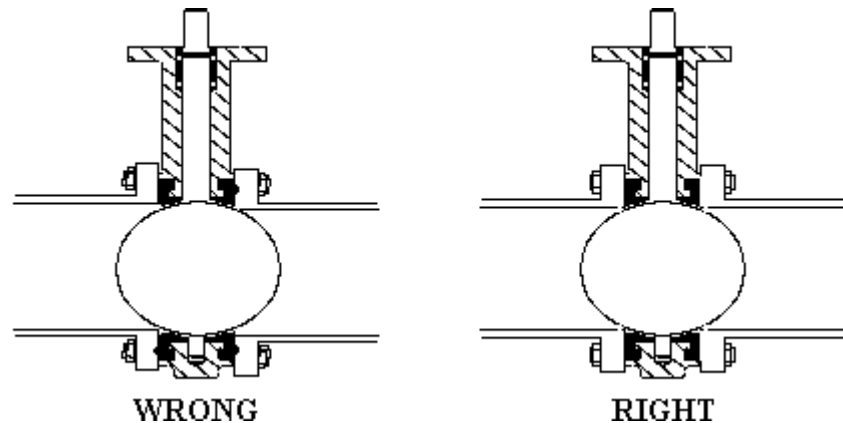

Piping misaligned; Results Disc O.D. strikes pipe I.D. causing disc edge damage, increased torque & leakage. Seat face o-rings seal improperly without engagement.

Piping aligned properly when bolts tightened, disc in full open position; Results - disc clears adjacent pipe I.D., seat face seals properly, no excessive initial torque.

B. Installation with Flange Welding

When butterfly valves are to be installed between ANSI welding type flanges, care should be taken to abide by the following procedure to ensure no damage will occur to the seat:

1. Place the valve between the flanges with the flange bores and valve body aligned properly. The disc should be in the 10° open position.
2. Span the body with the bolts.
3. Take this assembly of flange-body-flange and align it properly to the pipe.
4. Tack weld the flanges to the pipe

5. When tack welding is complete, remove the bolts and the valve from the pipe flanges and complete the welding of the flanges. Be sure to let the pipe and flanges cool before installing the valve.

NOTE: Never complete the welding process (after tacking) with the valve between pipe flanges. This causes severe seat damage due to heat transfer.

V. Maintenance and Repair

The many Bray features minimize wear and maintenance requirements. No routine lubrication is required. **All components - stem, disc, seat, bushing, stem seal, etc., are field replaceable, no adjustment is required.** If components require replacement, the valve may be removed from the line by placing the disc in the near closed position, then supporting the valve and removing the flange bolts.

VI. Disassembly and Assembly

A. Disassembly

1. **Series 20/21** - Remove handle, manual gear box or actuator from actuator mounting flange. Remove the body bolts and pull the lower body half away from the seat. Pull the seat and disc stem from the upper body half. Remove bushing and seal from the upper body. Push the seat into an oval shape and remove the disc stem by withdrawing the short stem end first.
2. **Series 30/31/34** - Remove the handle, gear operator, or actuator from actuator mounting flange. Remove the "Spirolox"® retaining ring and the two C-ring stem retainers from the stem hole, then remove the stem, bushing and seal. Remove the disc from the seat, protecting disc edge at all times. Push the seat into an oval shape, then remove the seat from the body.

B. Assembly

1. **Series 20/21** - Push the long stem end of the disc stem into the seat, then push the seat over the disc stem short stem. Place the disc stem and seat into the upper body half. Align the lower body bolt lugs with the upper body lugs and position lower body in the seat. Replace the body bolts and tighten. Install the stem seal, then the stem bushing. Replace handle, manual gear box or actuator on the actuator mounting flange. Note: The body halves have a matching casting node on one side only to ensure correct assembly of body halves.
2. **Series 30/31/34** - Push the valve seat into an oval and push it into the body with seat stem holes aligned to body stem holes. Insert stem seal and bushing. Push stem into the stem hole of body until the bottom of the stem is flush with the inner top edge of the seat. Install a light coating of silicone or grease on the I.D. of seat. Insert the disc into the seat by lining up the disc hole with the stem hole of the seat. Note: The broached double "D" flats in the disc must be toward the bottom of the valve body. With a downward pressure and rotating the stem back and forth, push the stem until the stem touches the bottom of the body stem hole. Make certain that when pushing stem through disc bottom, the broached flats of stem and disc are aligned. Replace the stem bushing and two stem retainers, then replace the "Spirolox"® retaining ring back into position.