

**BAKER**



**SPD**

A Baker Oil Tools company

**NEW  
IMPROVED  
DESIGN**

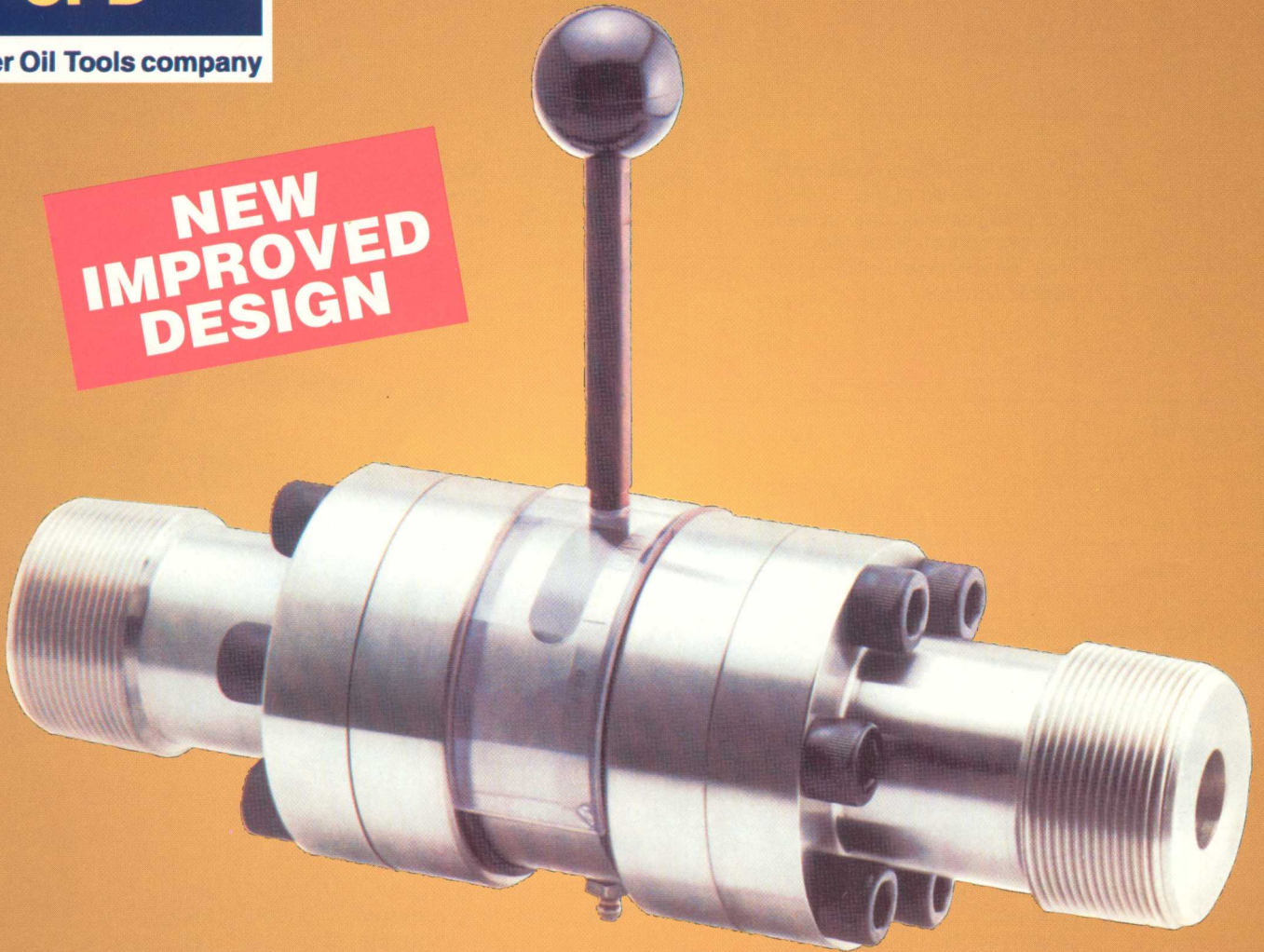

**INTRODUCING  
BAKER/WOODS UNIQUE IN-LINE  
FLOW-CONTROL CHOKE VALVE**



## PARTS LIST

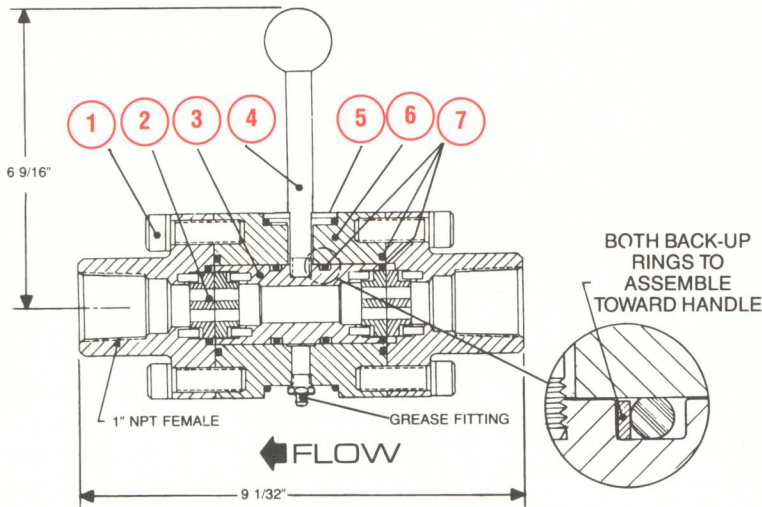

NOTE: WHEN UTILIZING SINGLE DISC SET  
INSTALL DOWN STREAM.

ESTIMATED WEIGHT for Male, Female and Grooved connections: 1" 7-21 lbs. — 2" 34-37 lbs.

\*For Weld-on Flanges, contact factory.  
\*\*Also available in Aluminum Bronze.

## 1" FLOW CONTROL VALVE\*\*

ITEM	PART NO.	DESCRIPTION
1	0620600	CAP SCREW SET (12 PC'S)
2	0620610	.250 CERAMIC DISC W/BAND
	0620615	.150 TUNGSTEN DISC W/BAND
	0620620	.355 CERAMIC DISC W/BAND
	0620625	.355 TUNGSTEN DISC W/BAND
3	0620650	SPOOL & PIN ASSY.
4	0620660	HANDLE ASSY.
5	0620670	WEATHER PROOF COVER
6	0620680	BODY CARBON STEEL
	0620685	BODY STAINLESS STEEL
7	0620700	COMPLETE O-RING SEAL KIT
8	0620710	2" MNPT HUB CARBON STEEL
	0620715	2" MNPT HUB STAINLESS STEEL
9	0620720	1" FNPT HUB CARBON STEEL
	0620725	1" FNPT HUB STAINLESS STEEL
10	0620730	1" WELD-ON HUB CARBON STEEL
	0620735	1" WELD-ON HUB STAINLESS STEEL
	0620740	2" WELD-ON HUB CARBON STEEL
	0620745	2" WELD-ON HUB STAINLESS STEEL
11	0620750	2" GROOVED HUB CARBON STEEL
	0620755	2" GROOVED HUB STAINLESS STEEL

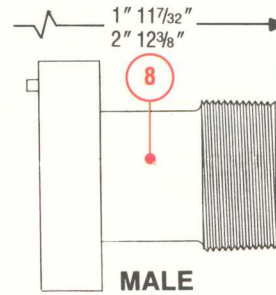

MALE

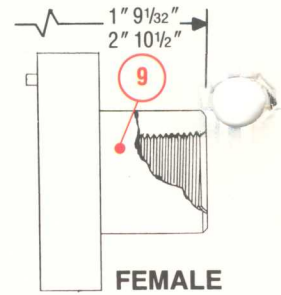

FEMALE

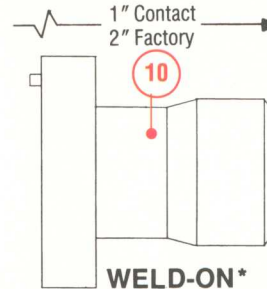

WELD-ON\*

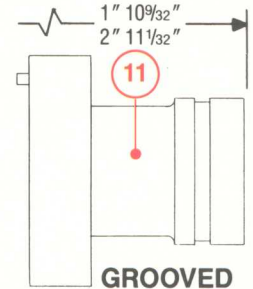

GROOVED

## OPTIONAL END CONNECTIONS

## 2" FLOW CONTROL VALVE

ITEM	PART NO.	DESCRIPTION
1	0620605	CAP SCREW SET (12 PC'S)
2	0620630	.250 CERAMIC DISC W/BAND
	0620635	.375 TUNGSTEN DISC W/BAND
	0620640	.500 CERAMIC DISC W/BAND
	0620645	.500 TUNGSTEN DISC W/BAND
3	0620655	SPOOL & PIN ASSY.
4	0620665	HANDLE ASSY.
5	0620675	WEATHER PROOF COVER
6	0620690	BODY CARBON STEEL
	0620695	BODY STAINLESS STEEL
7	0620705	COMPLETE O-RING SEAL KIT
	0620760	2" MNPT HUB CARBON STEEL
8	0620765	2" MNPT HUB STAINLESS STEEL
	0620770	2" FNPT HUB CARBON STEEL
9	0620775	2" FNPT HUB STAINLESS STEEL
	0620780	2" WELD-ON HUB CARBON STEEL
10	0620785	2" WELD-ON HUB STAINLESS STEEL
	0620790	2" WELD-ON HUB CARBON STEEL
11	0620795	2" WELD-ON HUB STAINLESS STEEL

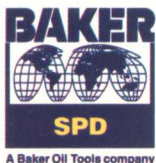

Office: (210) 304-5650  
FAX: (210) 304-5641  
WATS: 1-800-688-5650